



BS - BV series

Cubic photoelectric sensors
DECOUT® output - DC or AC



features

- Wide range of models: diffuse, retro-reflective, polarized
- Multifunctional DECOUT® output and logic connection possibilities (DC types)
- Multivoltage 20-253 Vac and T_{RIAC} output with NO/NC selectable (AC types)
- Sensitivity adjustment
- Standard cable exit or M12 plug exit
- LED status indicator
- Completely filled with resin
- High sensing range



web content



- Application notes
- Photos
- Catalogue / Manuals



Cubic DECOUT®
DC or AC

code description

BS 2 / 0 0 - 0 C

series	BS	DC - rectangular photoelectric sensor
	BV	AC - rectangular multivoltage photoelectric sensor
type	2	100 mm diffuse reflection
	4	200 mm diffuse reflection
	6	400 mm diffuse reflection
	8	1600 mm diffuse reflection
	C	8 m retro-reflective
NO / NC	0	NO / NC selectable output
NPN / PNP	0	NPN / PNP selectable output DC Triac output AC
housing	0	Plastic housing
cable / plug output	C	Right angle cable exit
	E	Right angle M12 plastic plug cable exit



available models

Cubic DECOUT®
DC or AC

model	distance	output	DC - DECOUT®	AC - TRIAC
diffuse reflection	100 mm	cable	BS2/00-0C	BV2/00-0C
		M12	BS2/00-0E	BV2/00-0E
	200 mm	cable	BS4/00-0C	BV4/00-0C
		M12	BS4/00-0E	BV4/00-0E
	400 mm	cable	BS6/00-0C	BV6/00-0C
		M12	BS6/00-0E	BV6/00-0E
	1.600 m	cable	BS8/00-0C	-
		M12	BS8/00-0E	-
retroreflective	8 m	cable	BSC/00-0C	BVC/00-0C
		M12	BSC/00-0E	BVC/00-0E

technical specification

	diffuse reflection				retrorefl.	diffuse reflection			retrorefl.
	BS2/00-0*	BS4/00-0*	BS6/00-0*	BS8/00-0*	BSC/00-0*	BV2/00-0*	BV4/00-0*	BV6/00-0*	BVC/00-0*
nominal sensing distance	100 mm ⁽¹⁾	200 mm ⁽¹⁾	400 mm ⁽²⁾	1.600 mm ⁽²⁾	8 m ⁽³⁾	100 mm ⁽¹⁾	200 mm ⁽¹⁾	400 mm ⁽²⁾	8 m ⁽³⁾
emission	infrared (880 nm)								
tolerance	+ 15 / - 5 % Sn								
corsa differenziale	5 %				10 %	5 %			10 %
repeatability	5 %								
operating voltage	10...30 Vdc				20...253 Vac / 50...60 Hz				
ripple	10 % max				-				
no-load supply current	25 mA				1,5 W				
load current	100 mA				5 mA / 300 m ARMS				
inrush current	-				6 A (ton = 10 ms)				
leakage current	≤ 10 µA				1,5 m ARMS max (supply V = 253 Vac)				
output voltage drop	1,2 Vmax				2,5 Vmax				
output type	DECOUT® (PNP, NPN, N0, NC selectable)				TRIAC (N0, NC selectable)				
switching frequency	80 Hz				25 Hz				
power on delay	200 ms								
temperature range	- 25°C...+ 70°C (without freeze)								
power supply protections	transient								
supply electrical output	short circuit (autoreset)				-				
temperature drift	≥ 10 % Sr								
protection degree	IP65 (EN60529) ⁽⁴⁾								
EMC	in conformity with the EMC Directive according to EN 60947-5-2								
external light interference	3,000 lux (incandescent lamp), 10,000 lux (sunlight)								
LEDs	red (output energized)								
housing material	ABS polyetilene (cable exit)								
optic material	PMMA								
weight (approximate)	185 g (50 g mounting bracket ST01)								

⁽¹⁾ With 100x100 mm white matt paper ⁽²⁾ With 200x200 mm white matt paper ⁽³⁾ With standard reflector Ø80 mm (RL110 supplied separately) ⁽⁴⁾ Protection guaranteed only with plug cable well mounted

BS - BV

electrical diagrams of the connections

BS*/00-0* DECOU[®] exit ⁽¹⁾

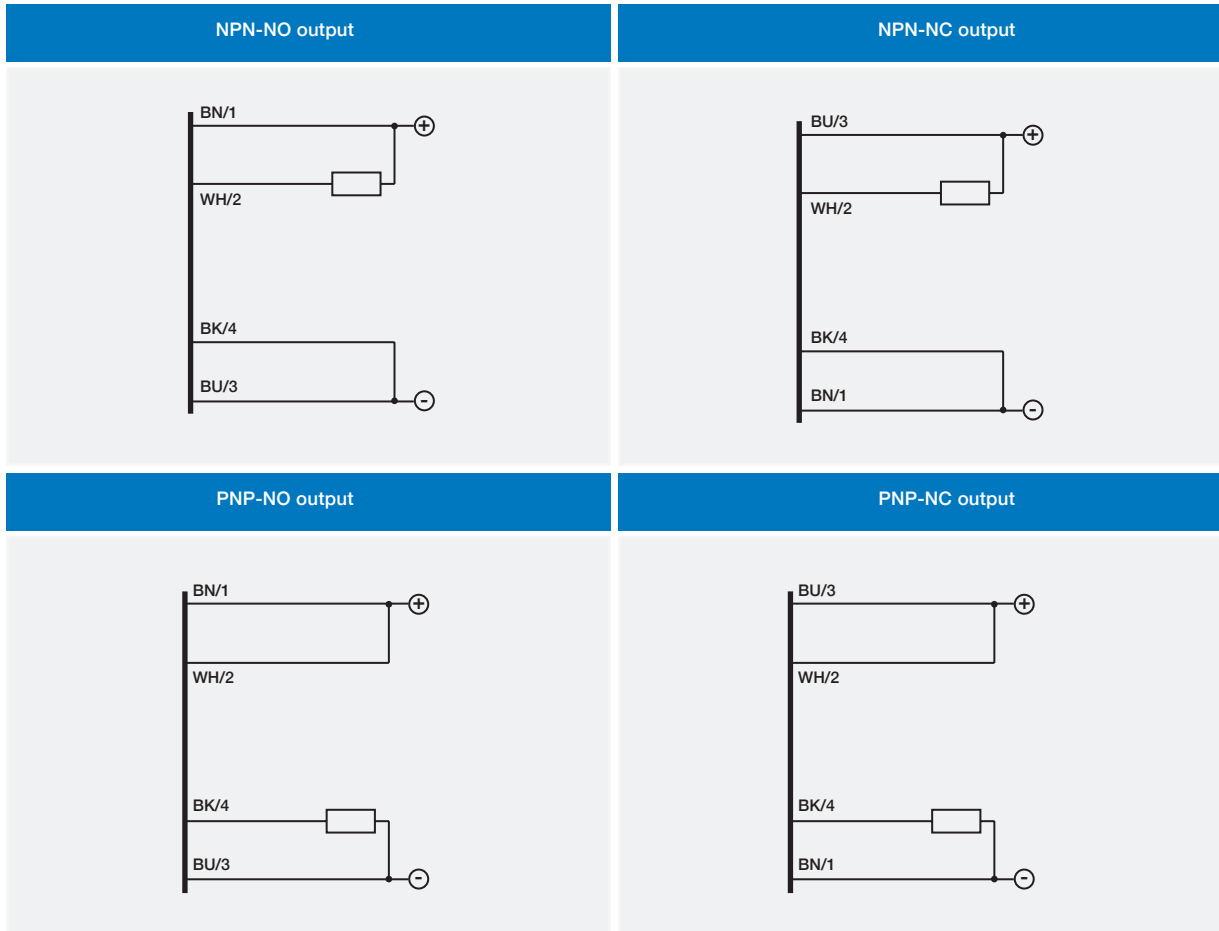

BN brown
BU blue
BK black
WH white

electrical diagrams of the connections

BV*/00-0* T_{RIAC} exit ⁽²⁾

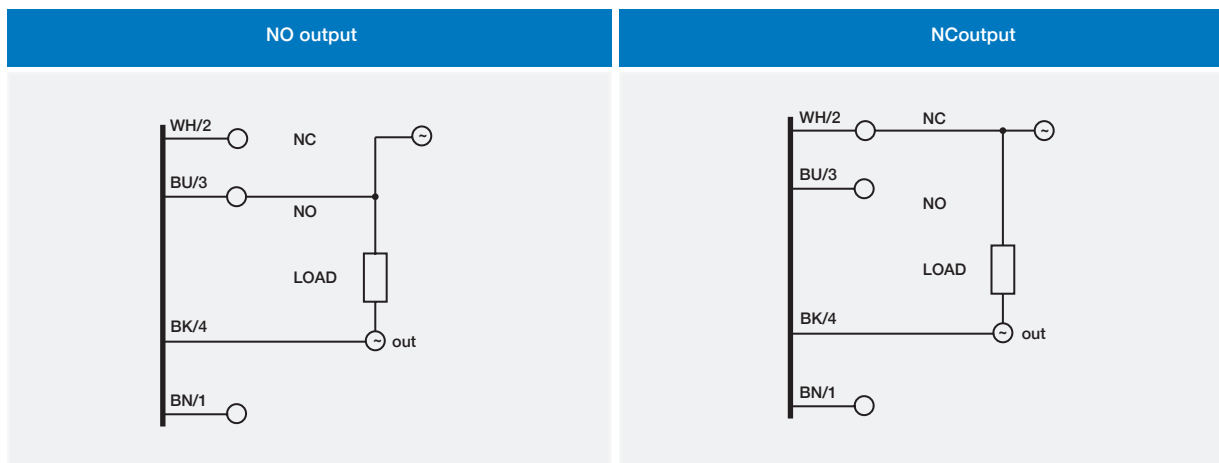

BN brown
BU blue
BK black
WH white

Notes:

⁽¹⁾ In case of combined load, resistive and capacitive, the maximum admissible capacity $C = 0,2 \mu F$, for maximum output voltage and current.

⁽²⁾ Through proper wiring for the connection cable BV models in AC permit one to select the output state.

Output state NO:

BLUE = power supply

WHITE = disconnected (isolate on a terminal)

Output state NC:

WHITE = power supply

BLUE = disconnected (isolate on a terminal)



Cubic DECOU[®]
DC or AC



M12

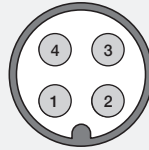

response diagrams

direct diffuse models

B*2/00-** excess gain

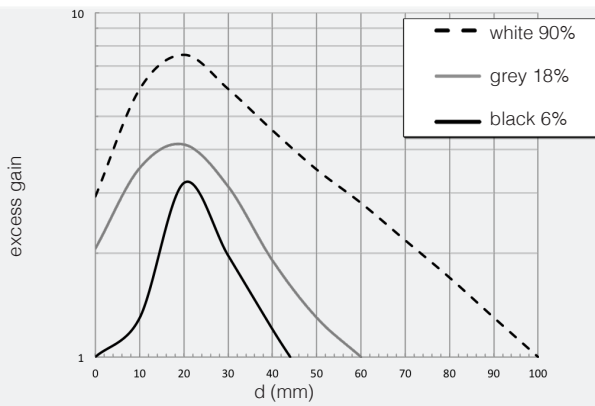

B*2/00-** spot dimension

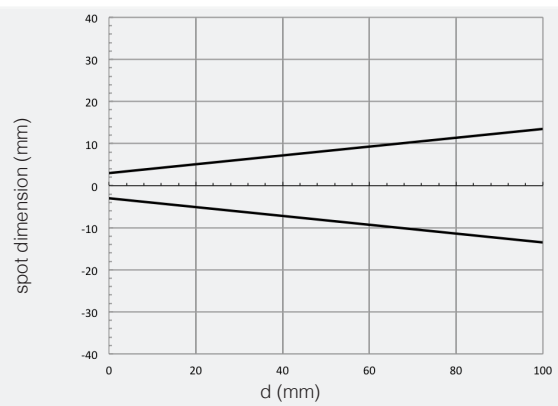

B*2/00-** parallel displacement

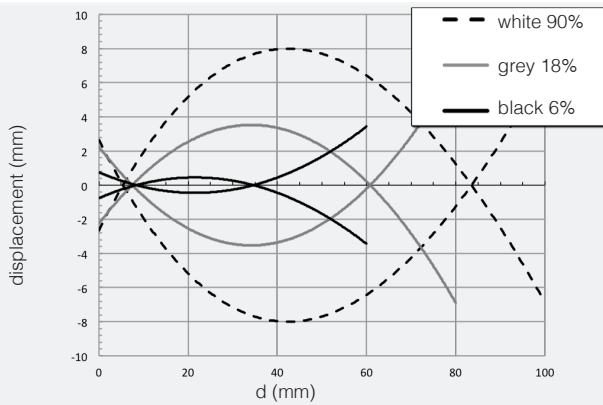

B*4/00-** spot dimension

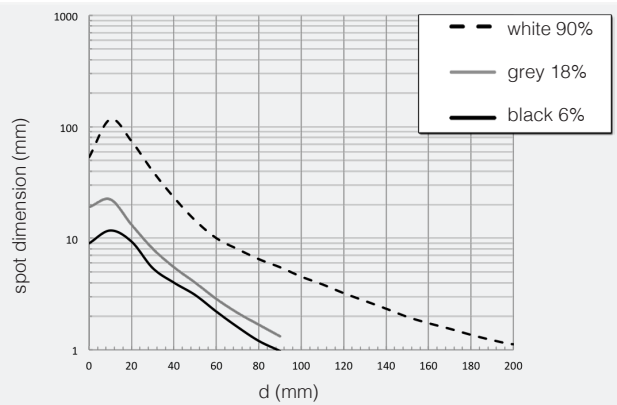

B*4/00-** parallel displacement

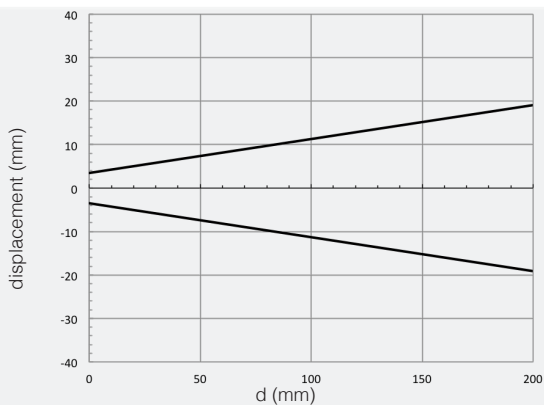

B*4/00-** spot dimension

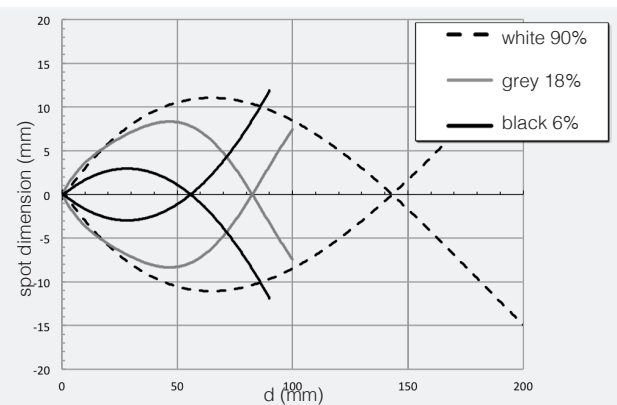



B*6/00-**-** excess gain

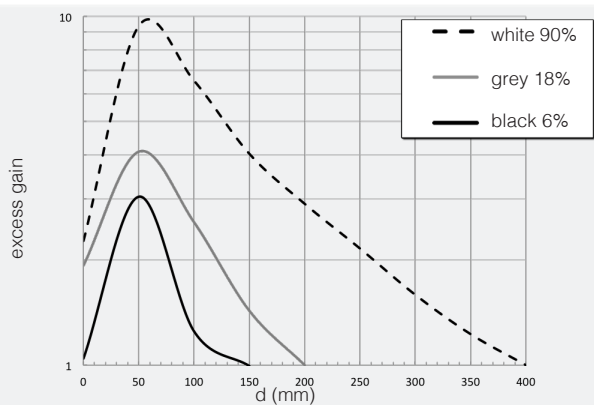

B*6/00-**-** spot dimension

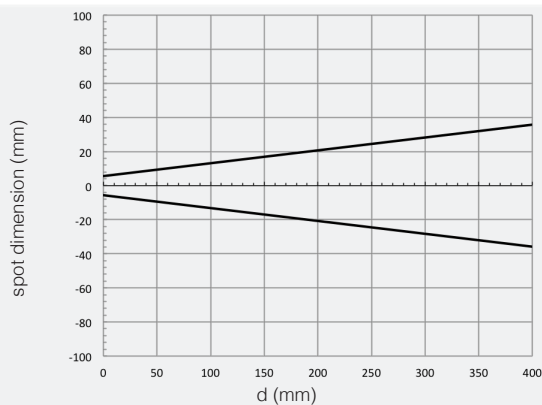

B*6/00-**-** parallel displacement

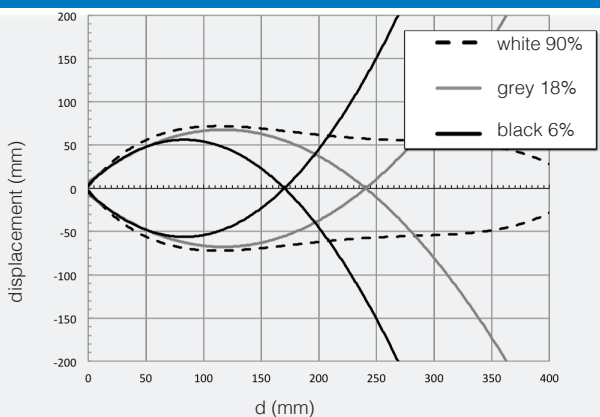

B*8/00-**-** excess gain

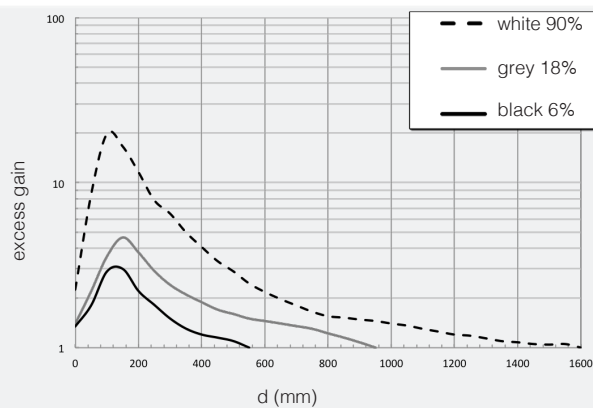

B*8/00-**-** spot dimension

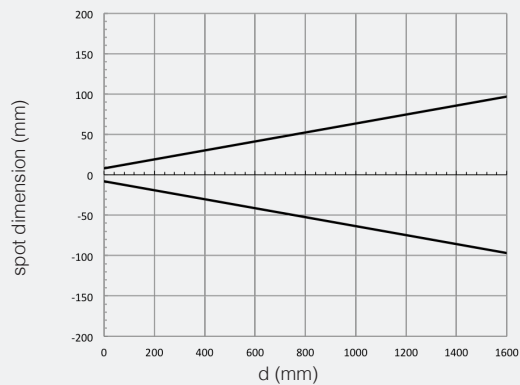

B*8/00-**-** parallel displacement

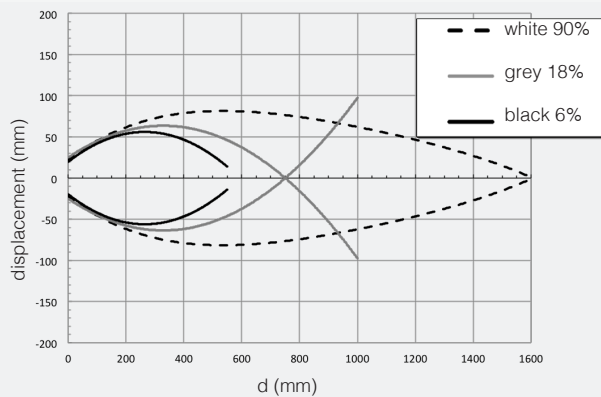

response diagrams

retro-reflective models (diagrams detected with RL110)

B*C/0*-**-** excess gain

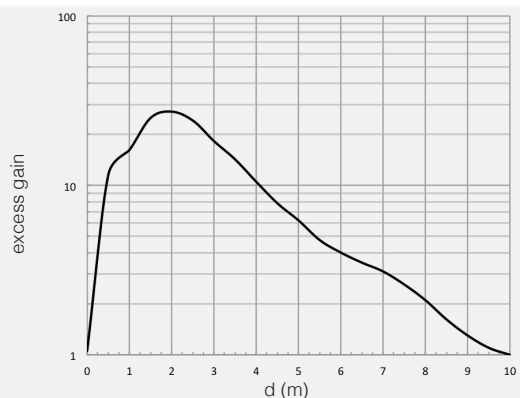

B*C/0*-**-** spot dimension

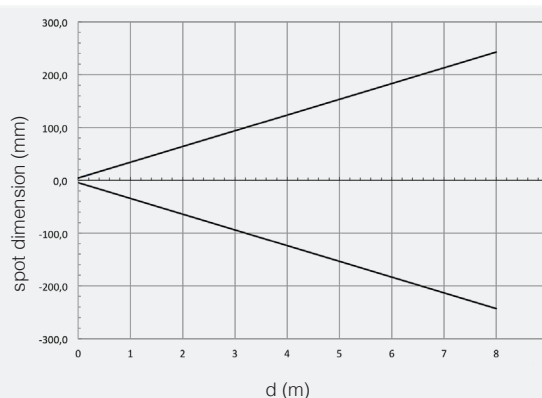



response diagrams

retro-reflective models

B*C/0*-** parallel displacement

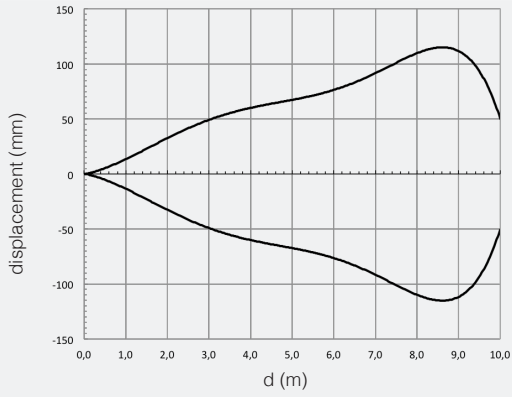

dimensions (mm)

B*2/00-0C - B*4/00-0C - B*6/00-0C - B*8/00-0C

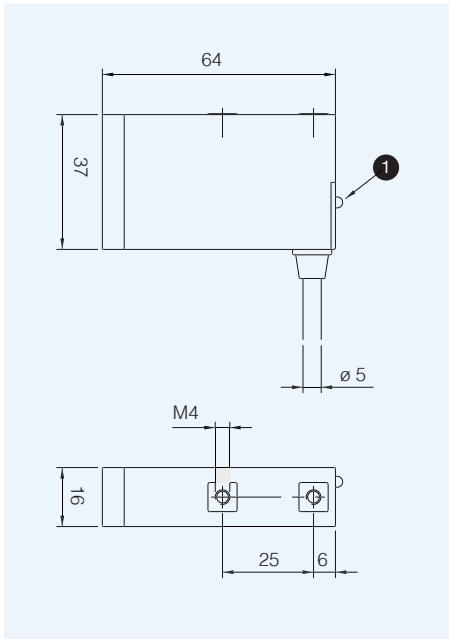

B*C/00-0C

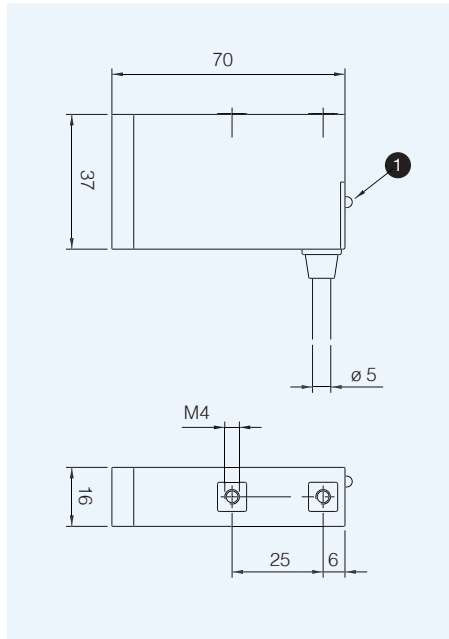

B*2/00-0E-B*4/00-0E-B*6/00-0E-B*8/00-0E

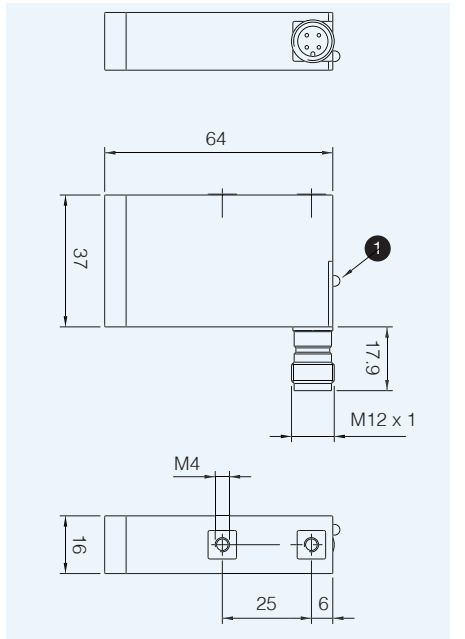

B*C/00-0E

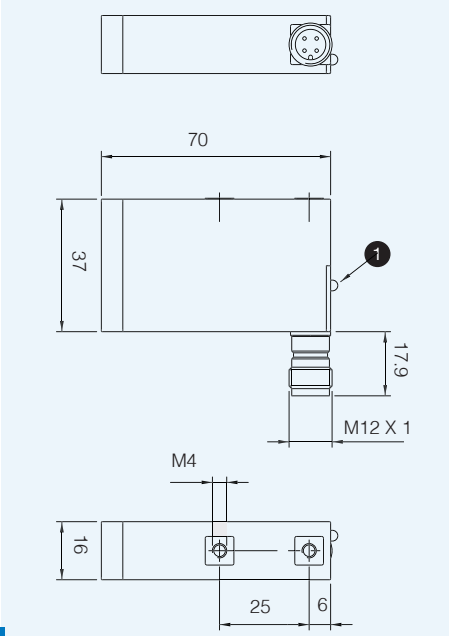

1 red LED (output state)

Plugs CD series - Accessories ST series